

S4.1

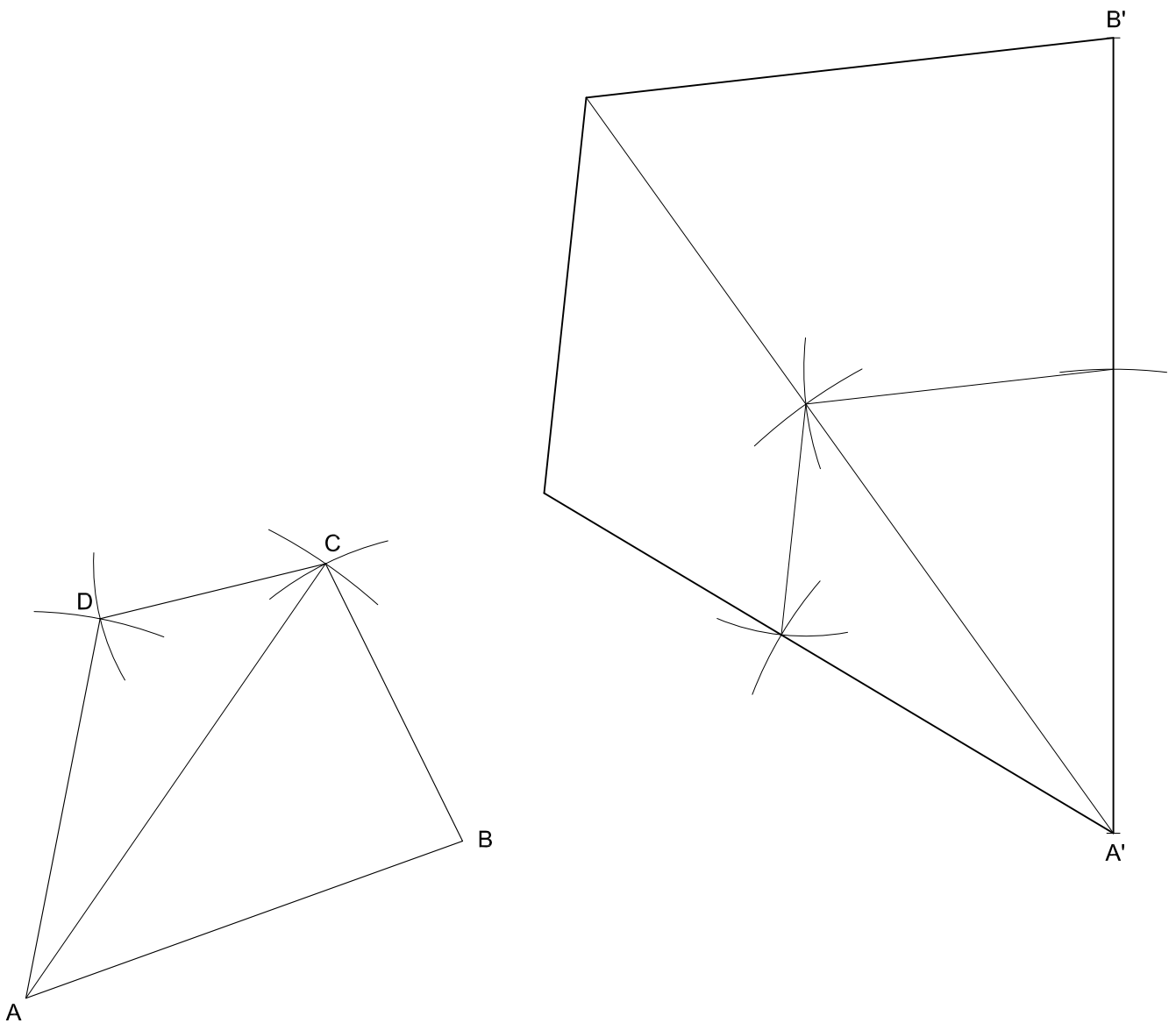

S4.2A

En el dibuix, la longitud de l'aresta ab-a'b' correspon al segment a'b'', que mesura 4,7 cm.

La longitud real de l'aresta ab-a'b' és de m.

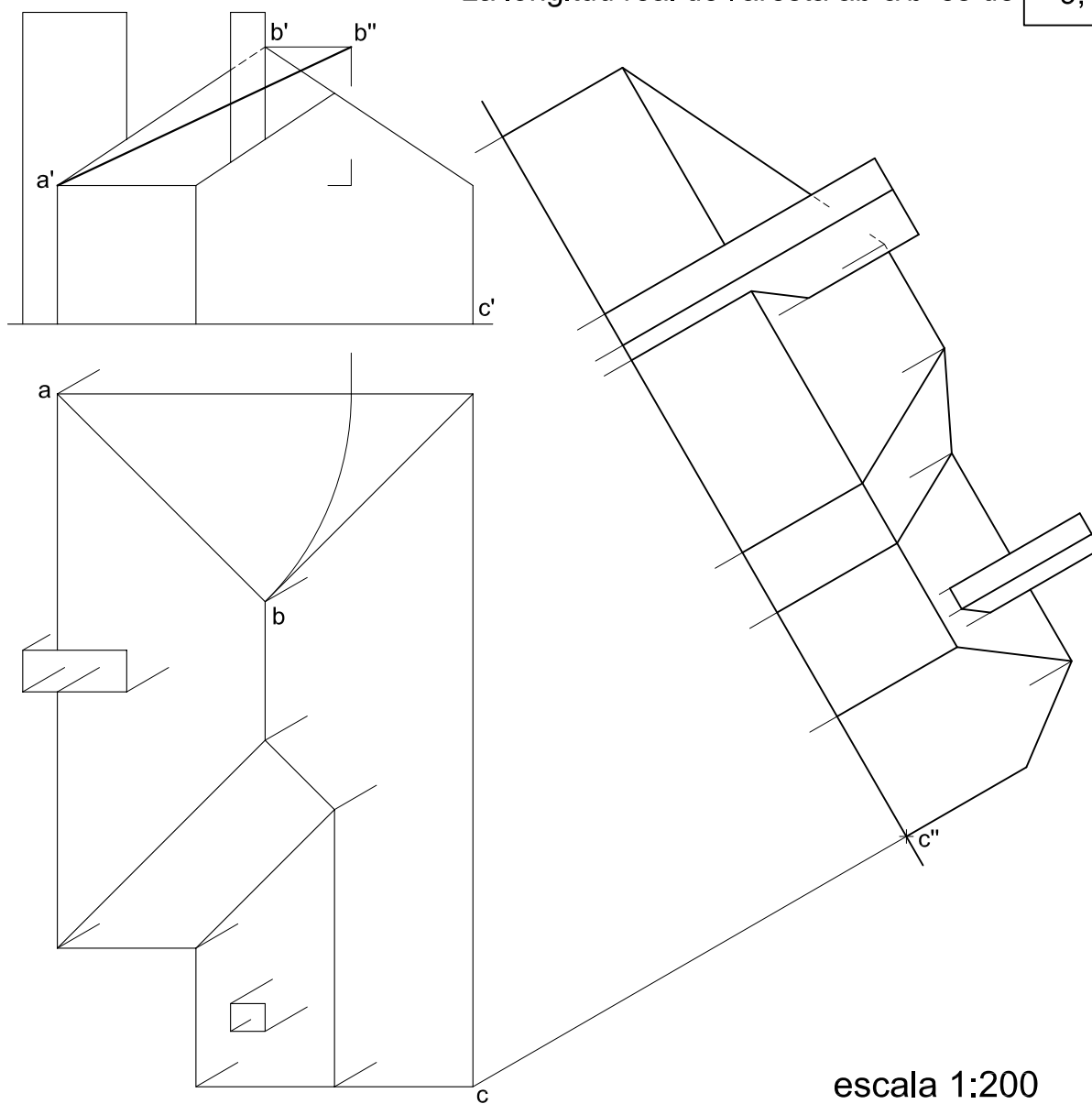

S4.2B

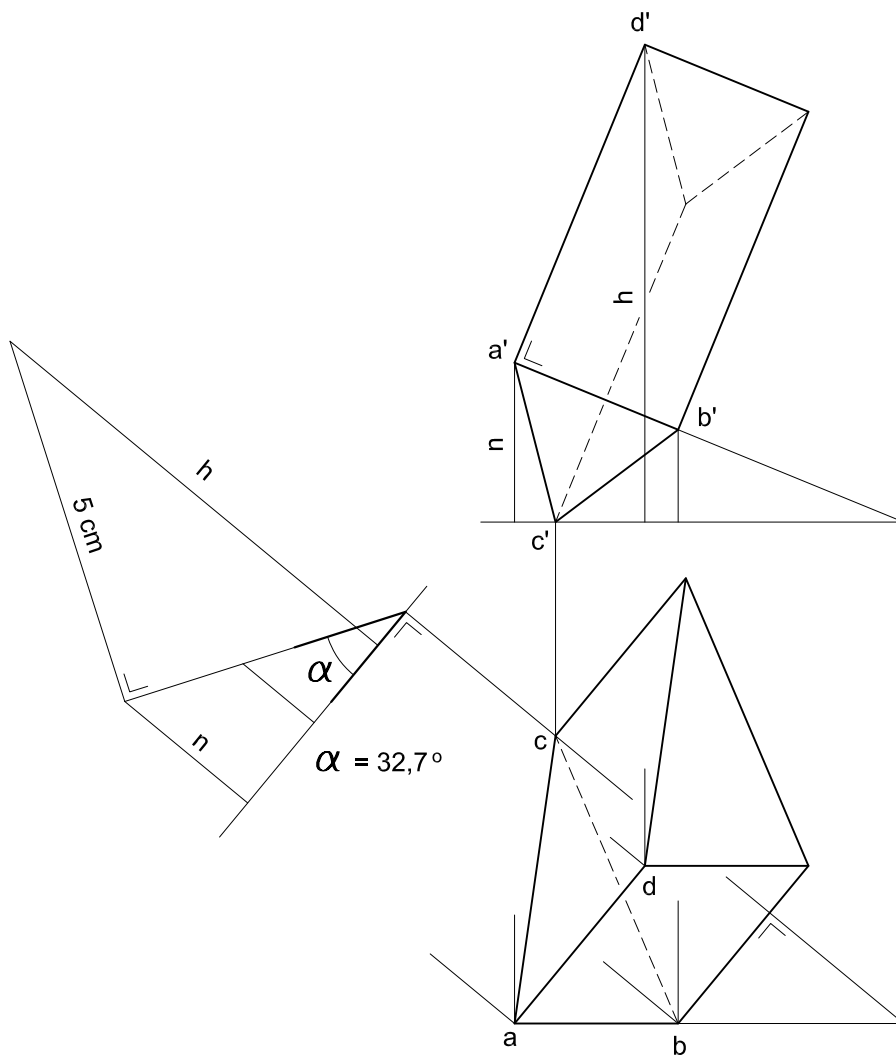

S4.3A

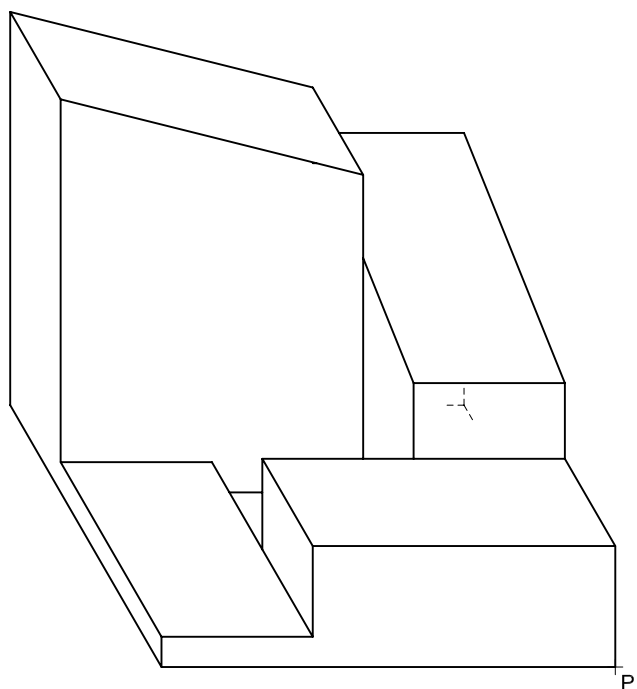
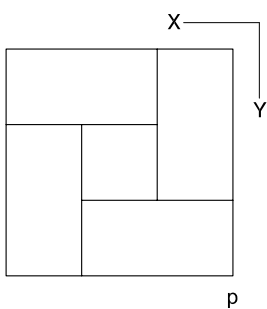
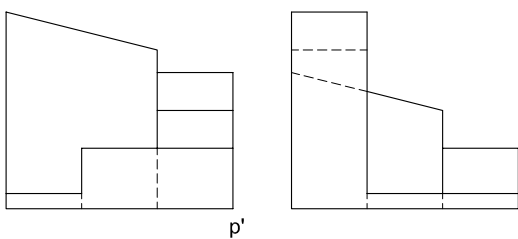
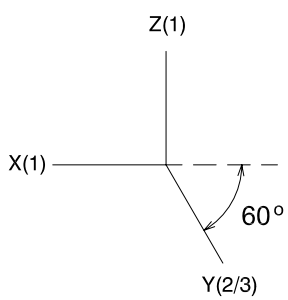

S4.3B

