

SÈRIE 1

S1.1A

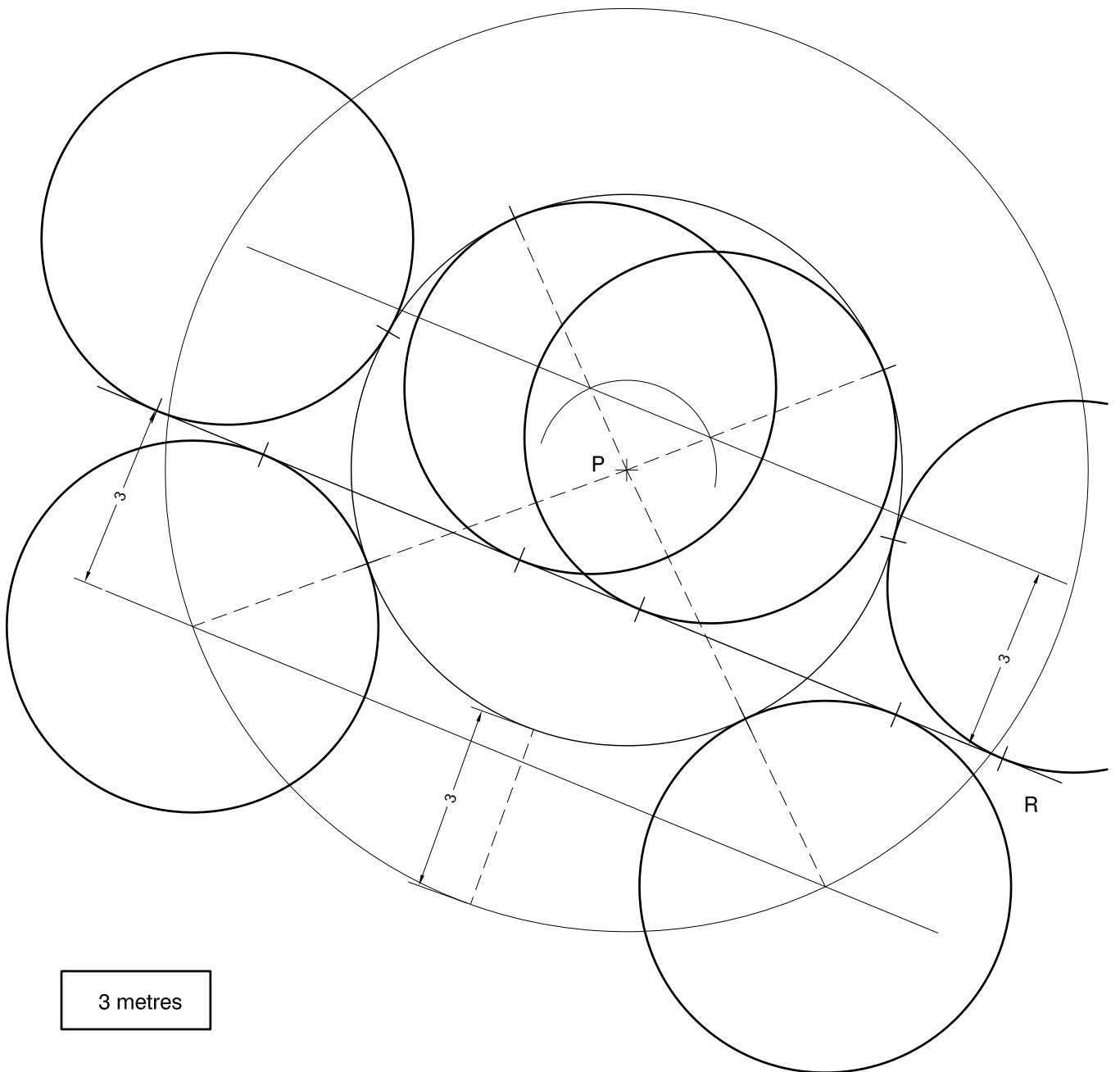

S1.1B

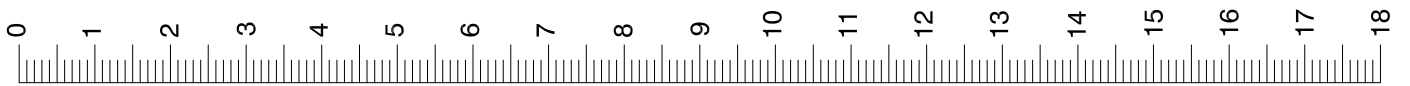
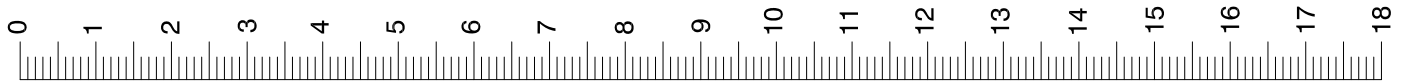

AB = 9 cm
BC = 7 cm
AD = 8,5 cm

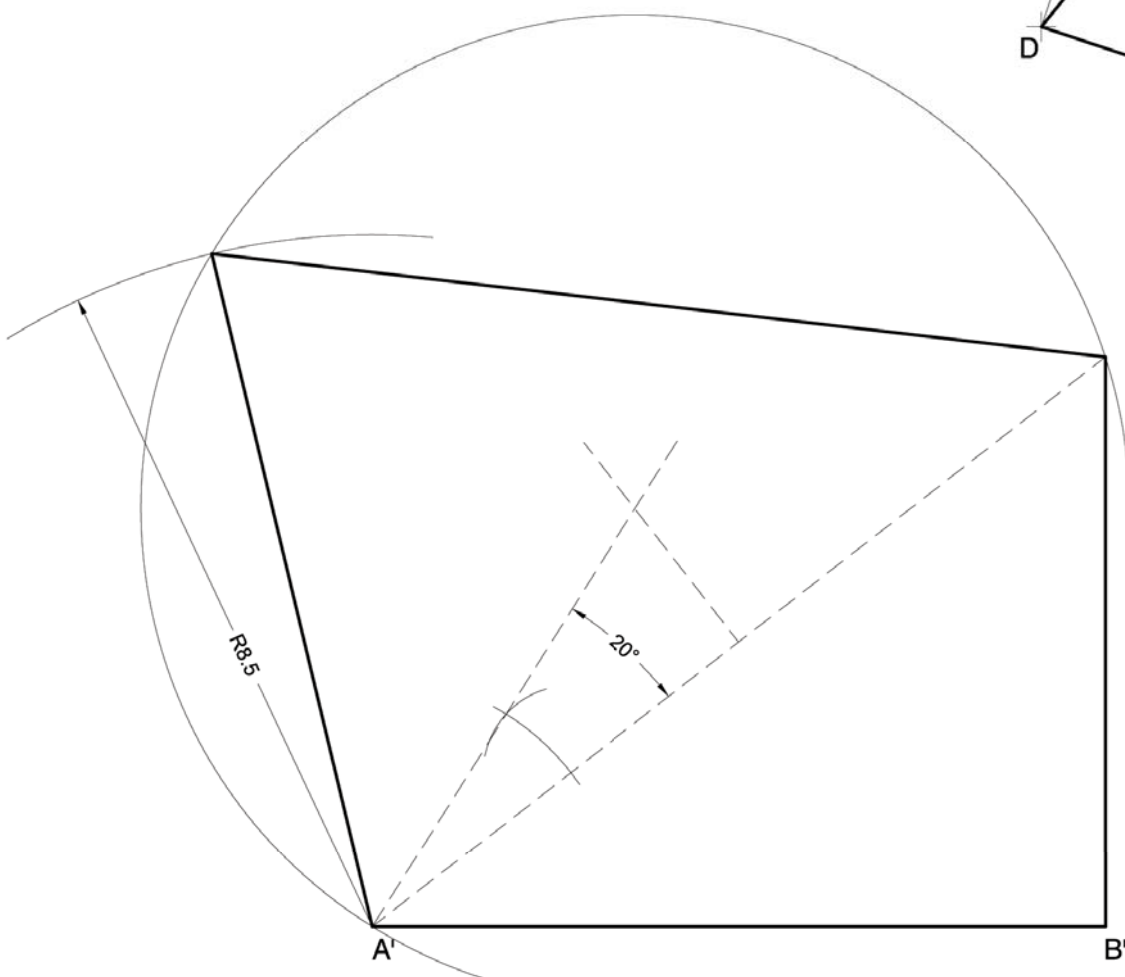
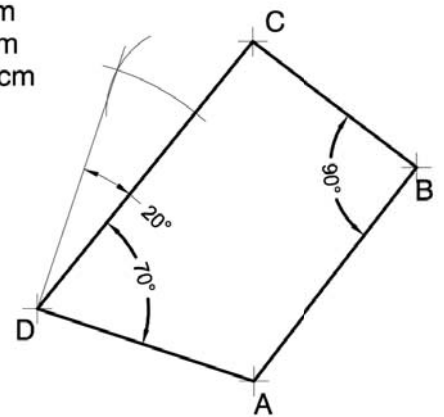

A'B' equival a 6,75 m de la realitat. Per tant, l'escala del dibuix és

1:75

S1.2A

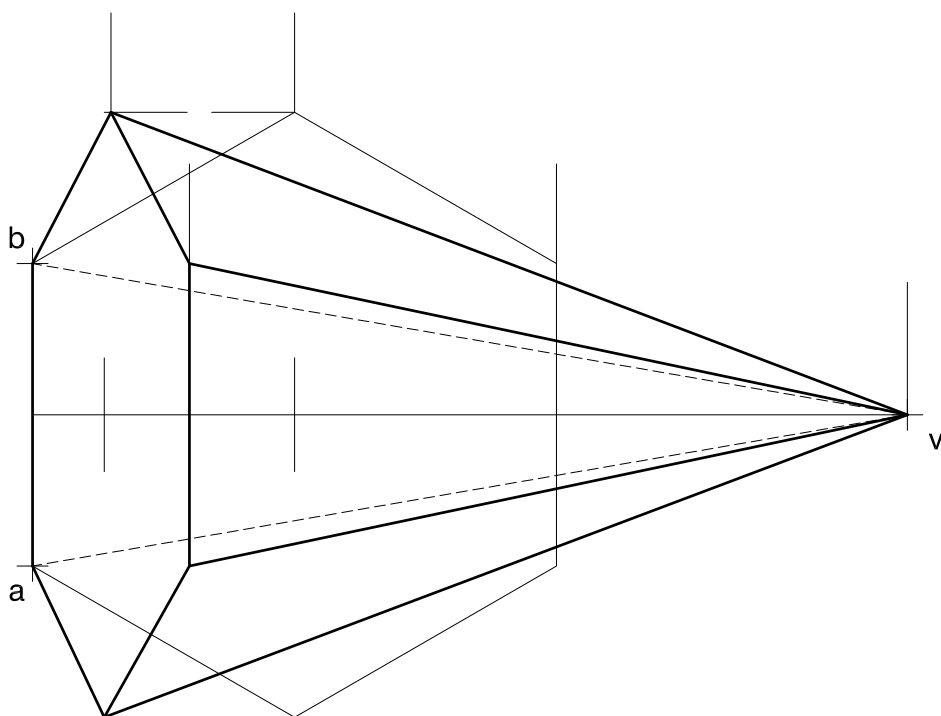
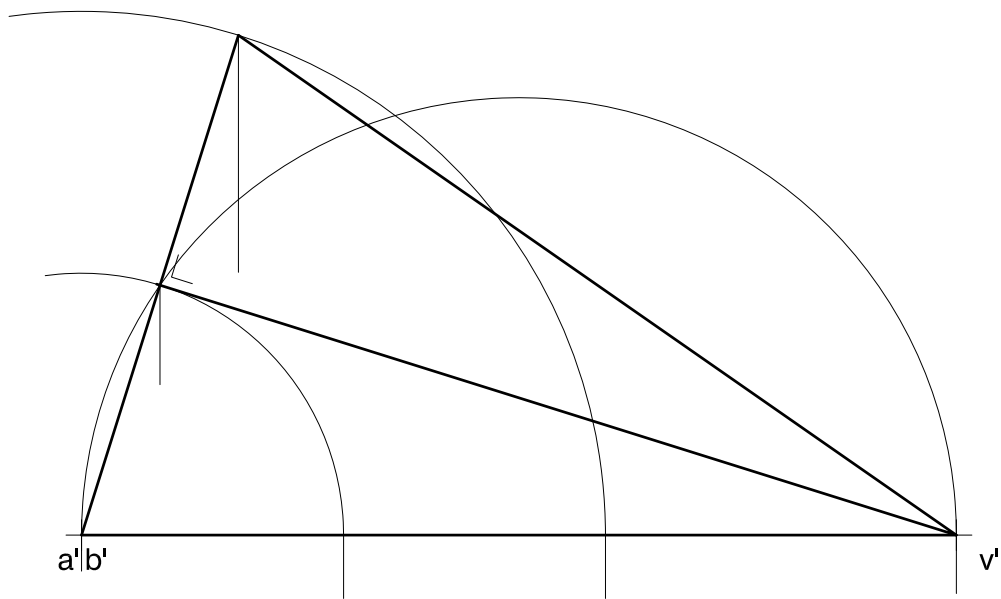
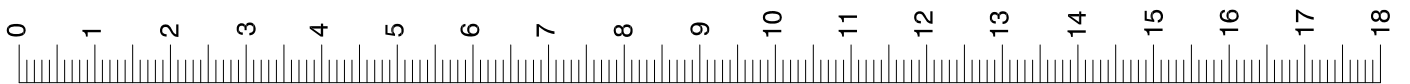

S1.2B

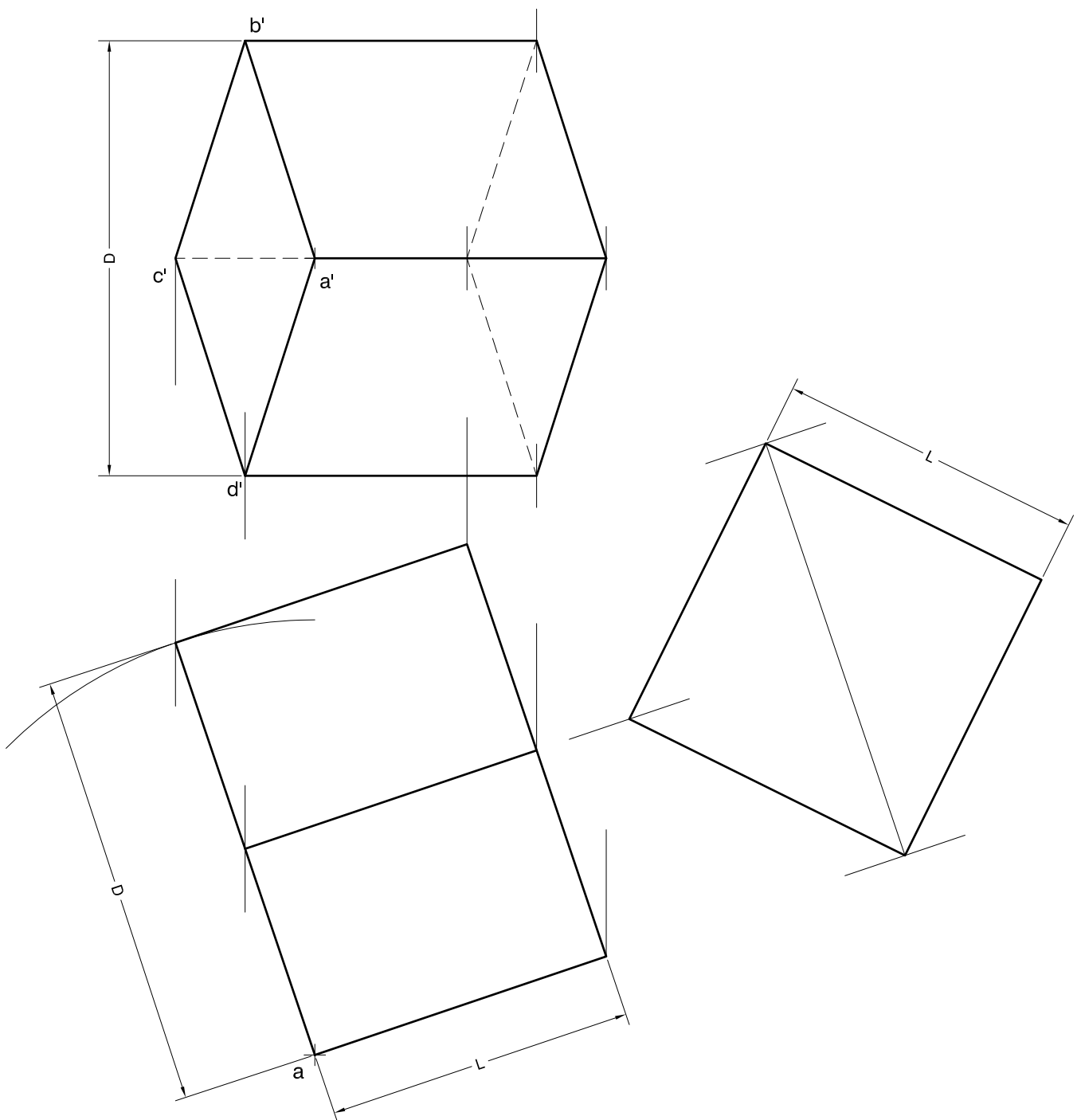
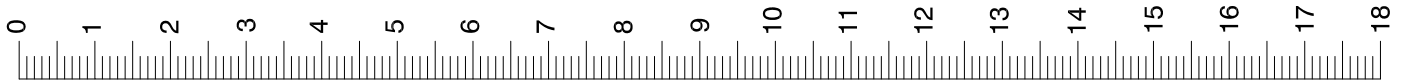

S1.3A

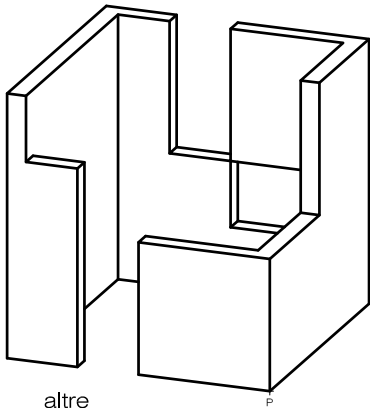
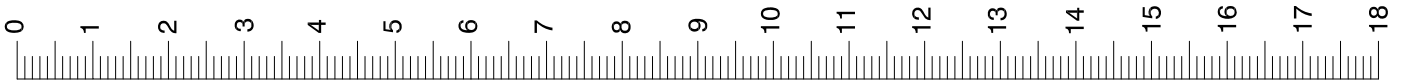

altre possible solució

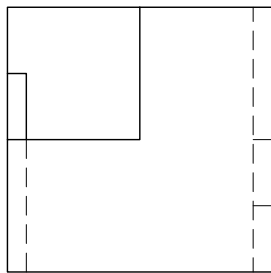
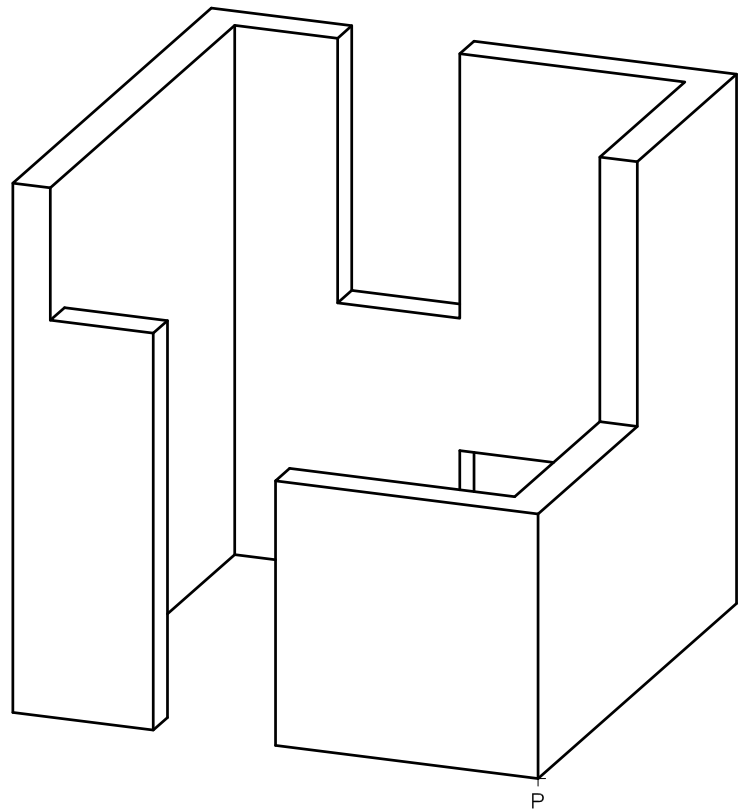

P'

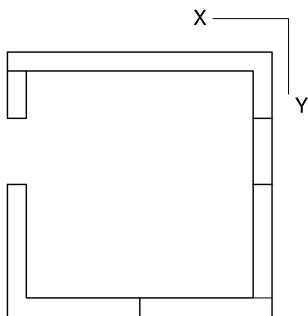

P

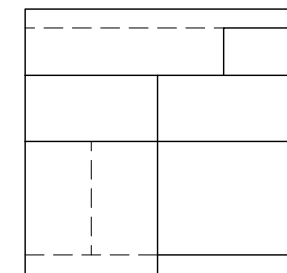

P'

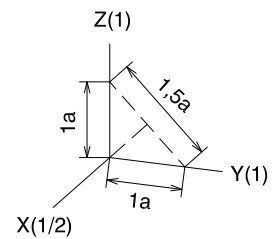

S1.3B

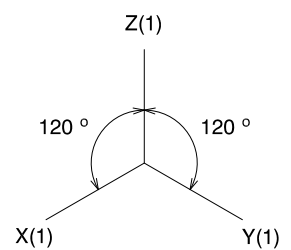
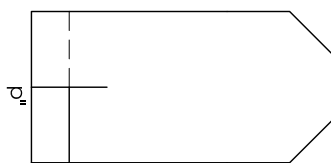
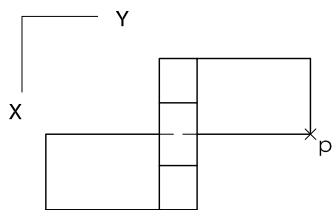
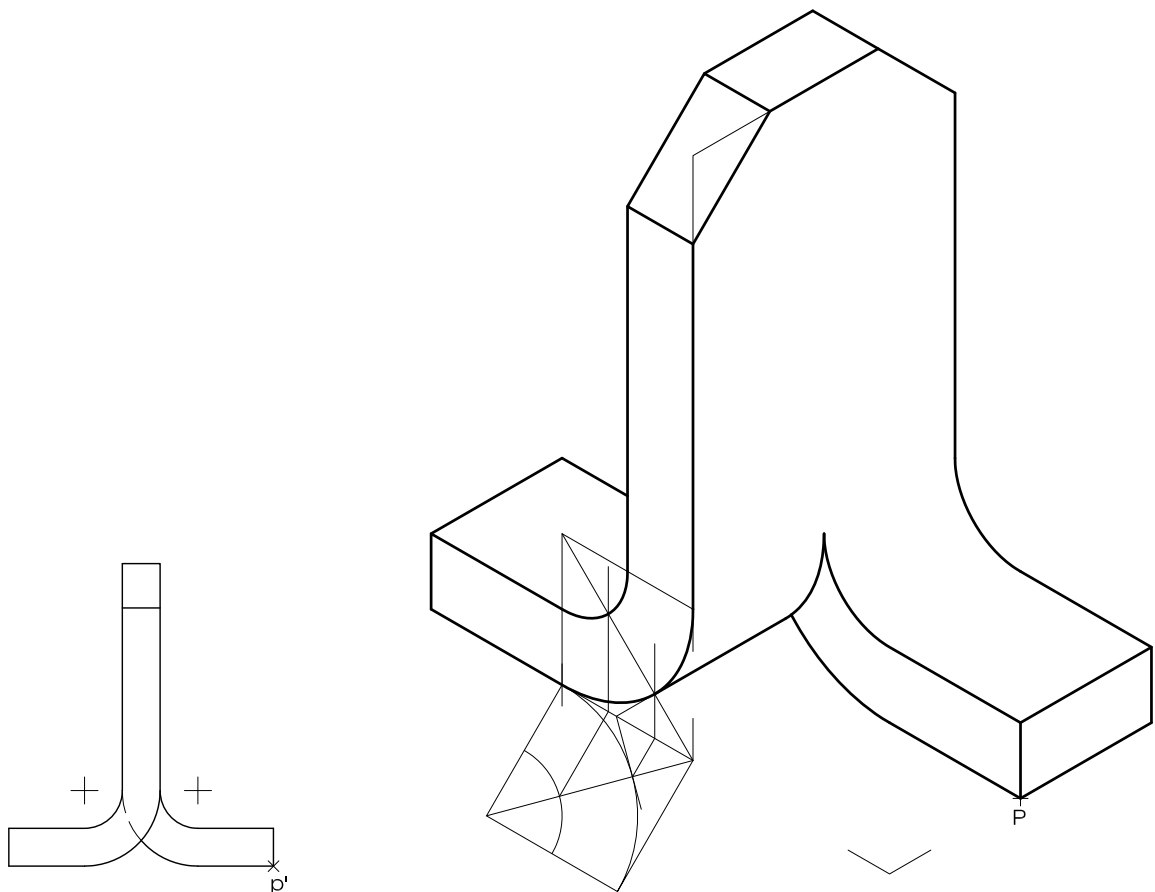
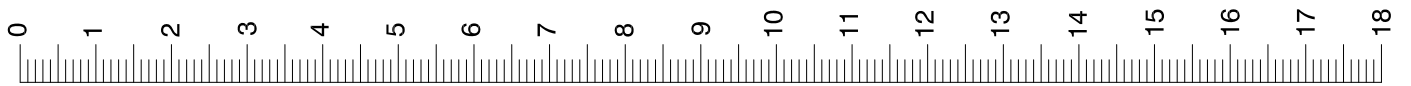

S4.1A

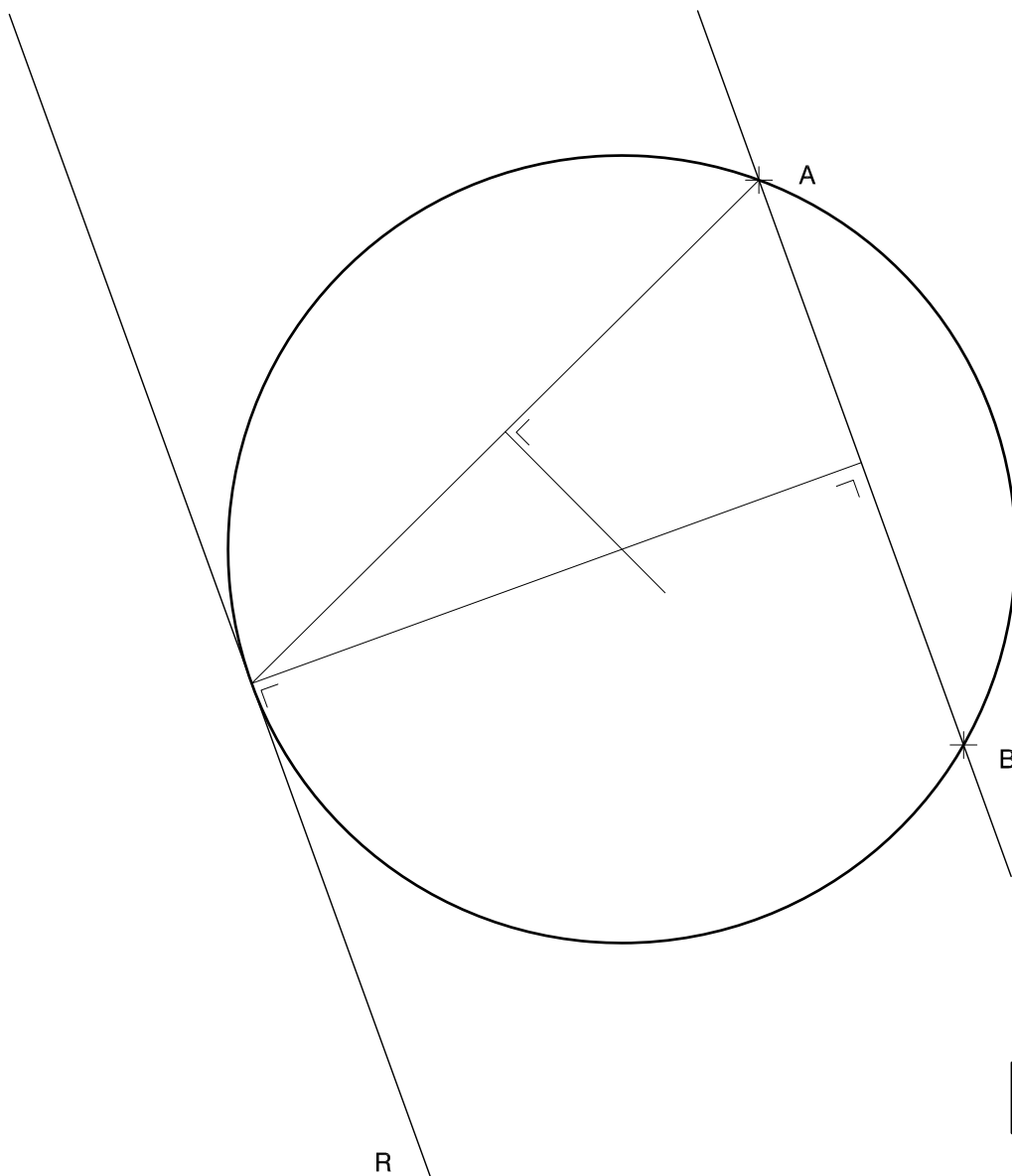
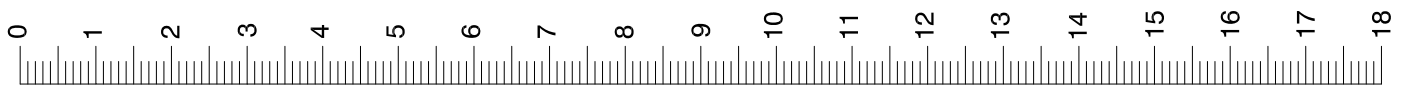

12 metres

S4.1B

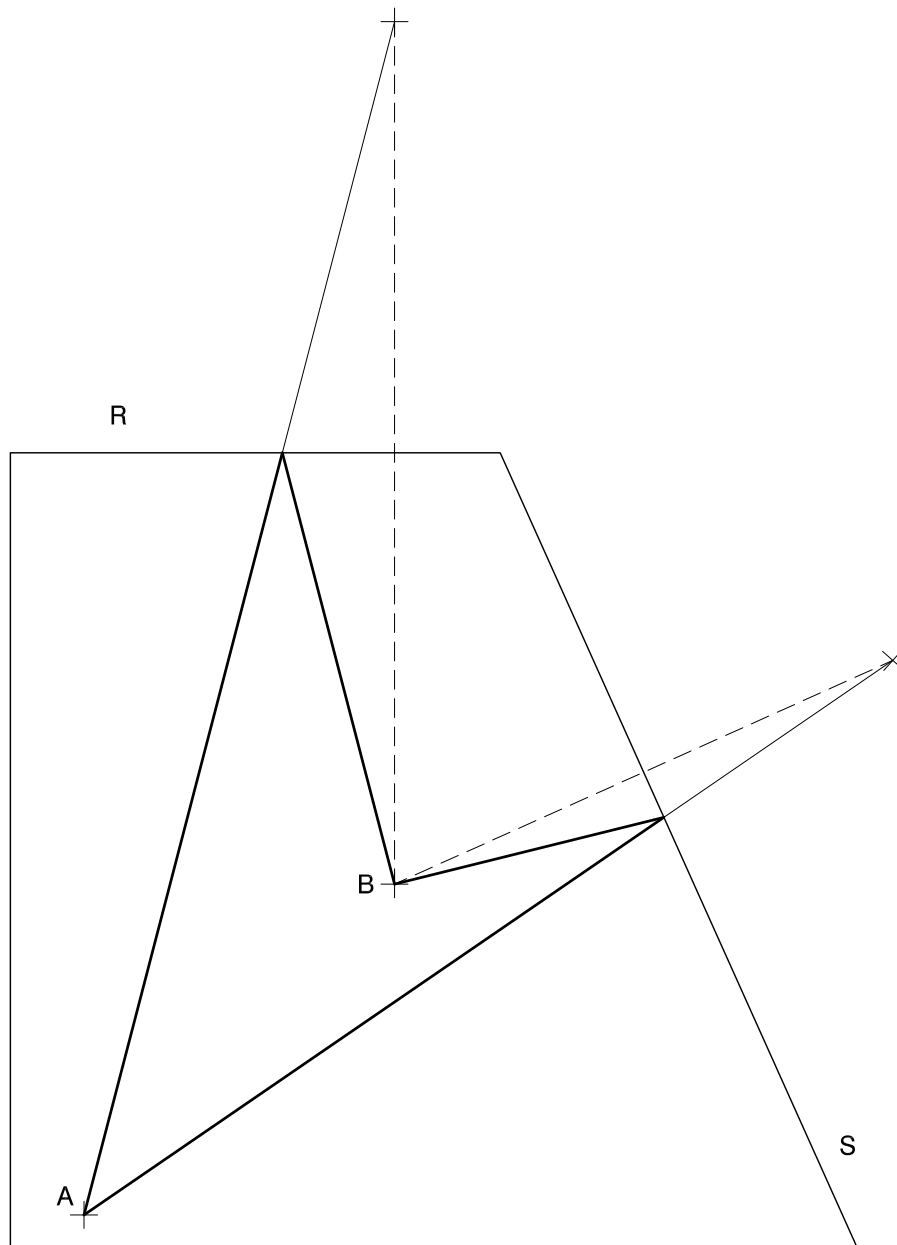

S4.2A

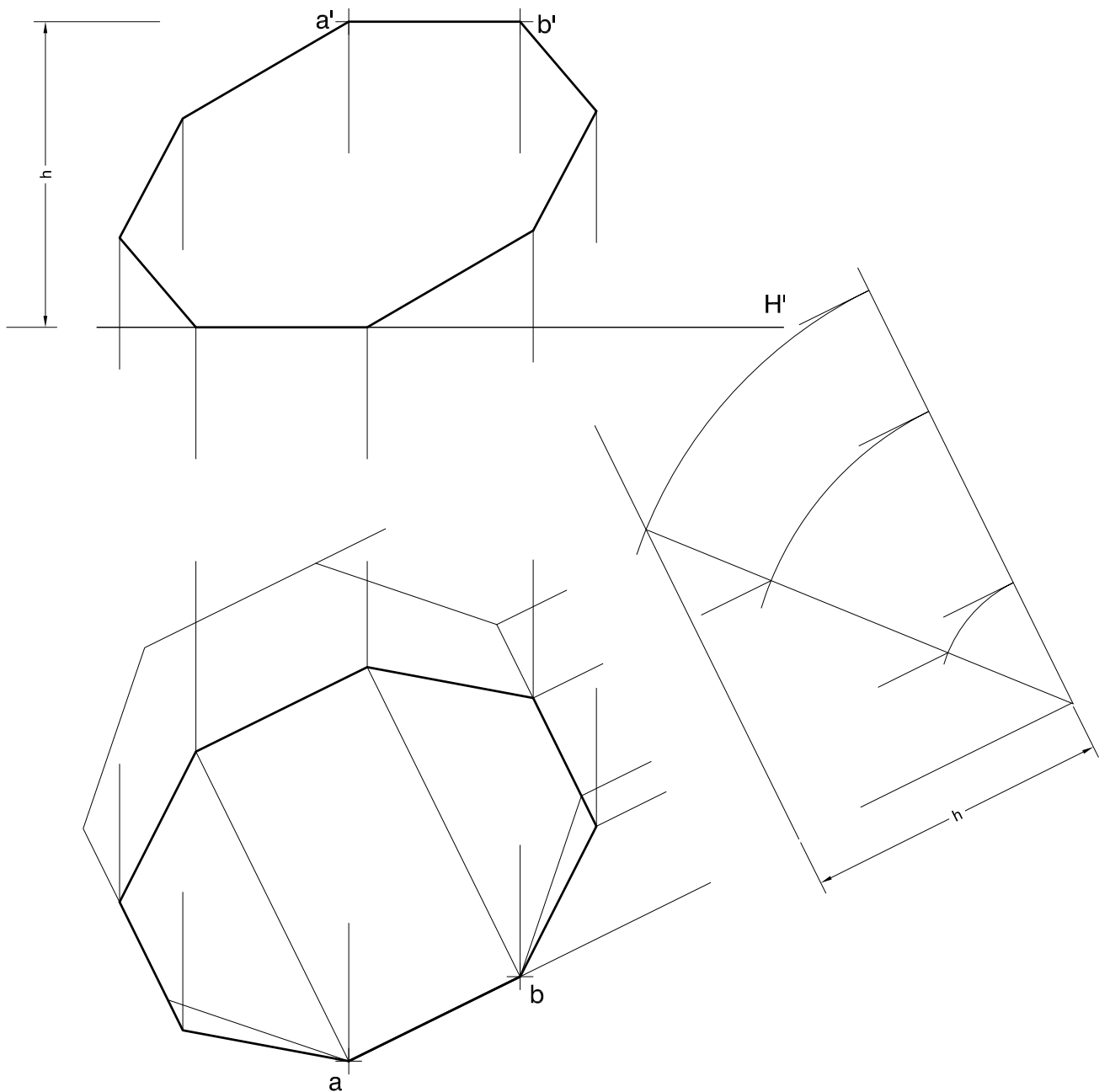

S4.2B

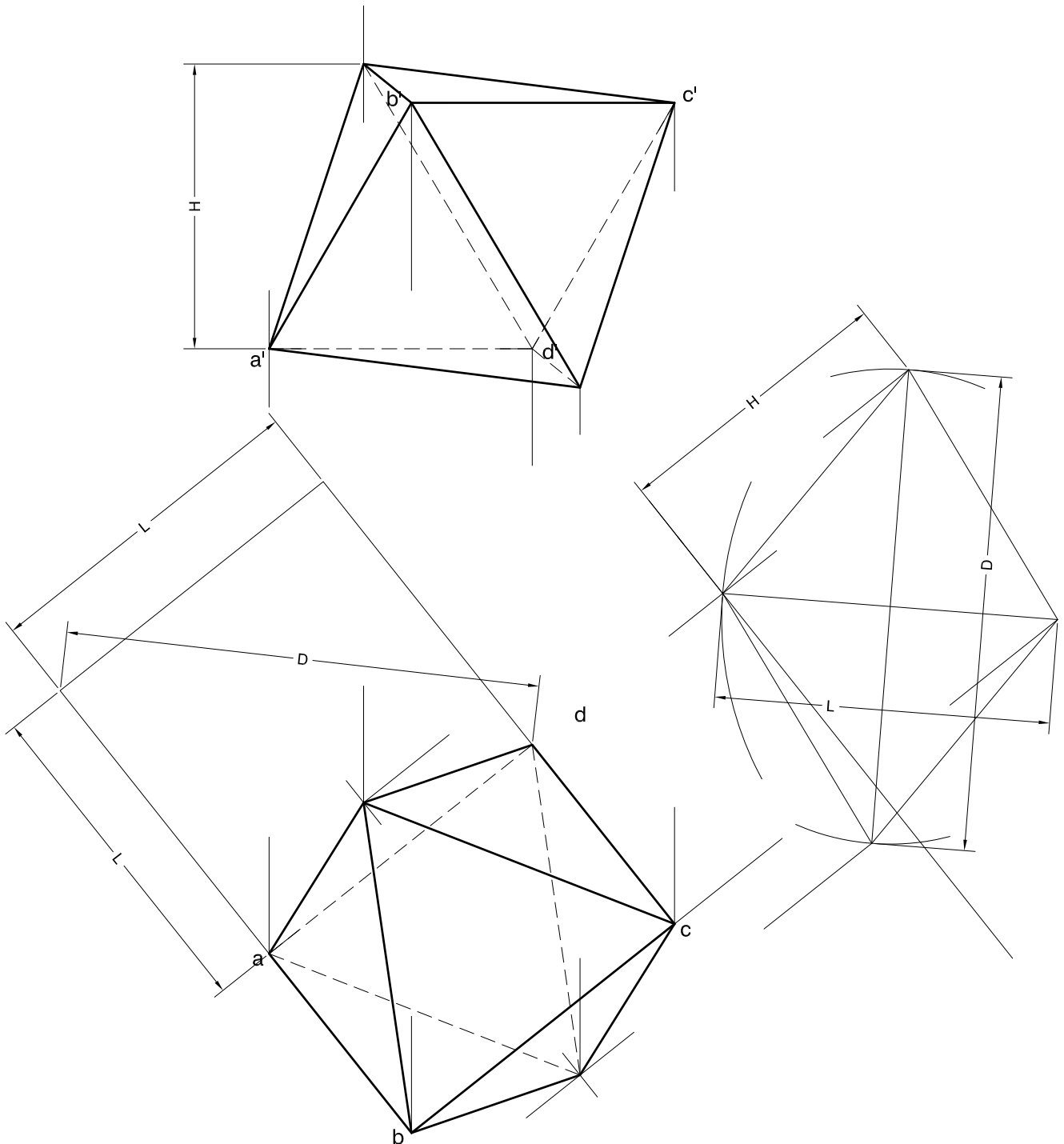
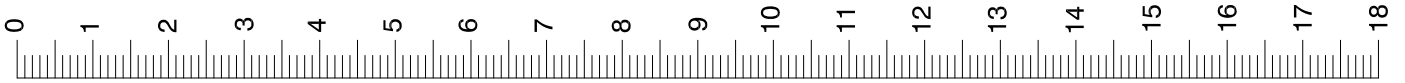

S4.3A

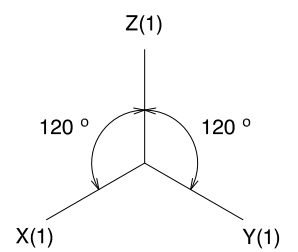
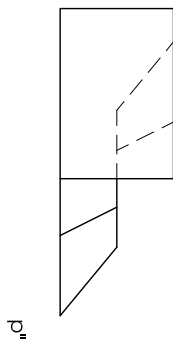
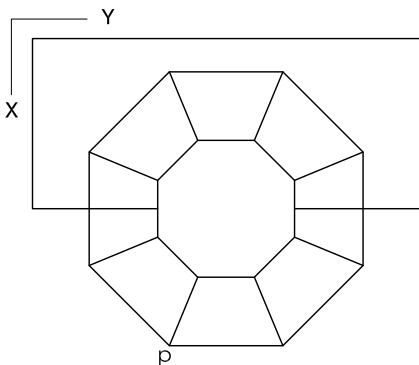
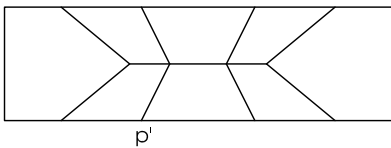
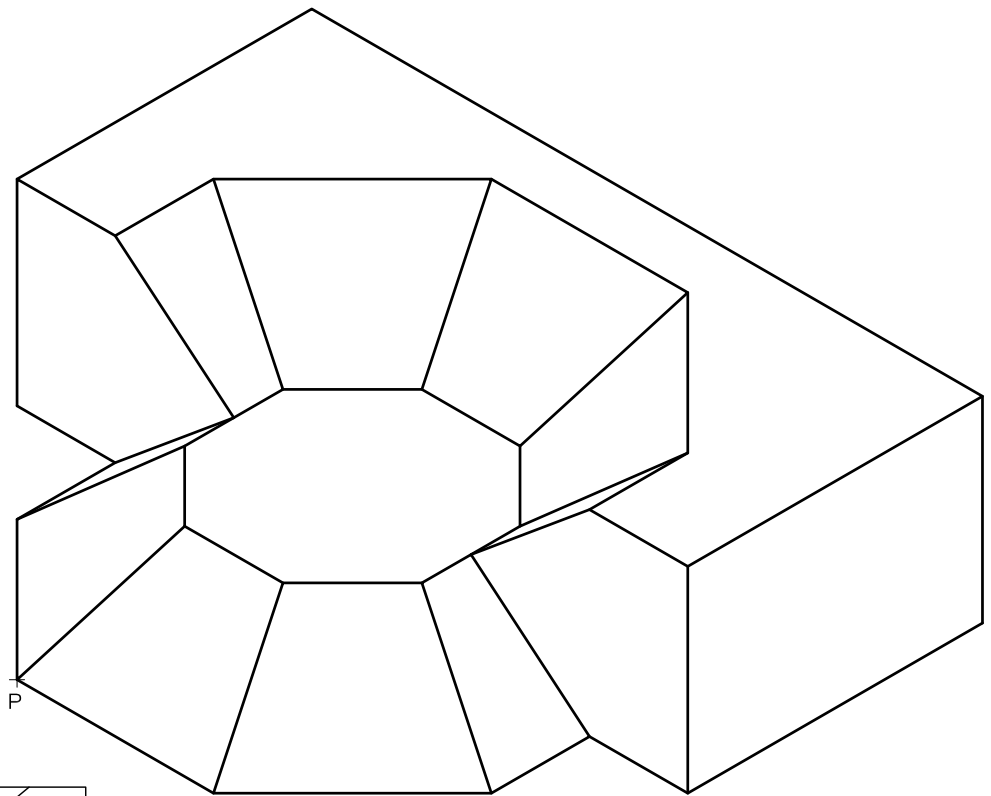
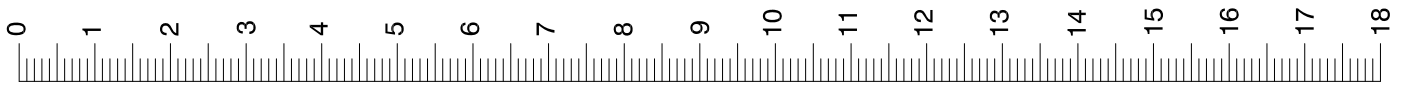

S4.3B

